

## Description

- 1-12 metre sensing range
- 16 to 56 parallel scanning beams
- Active height of 1800 mm to 2520 mm
- Length of 1948 mm to 2668 mm
- 3 different channel placement models
- Cable or plug connection
- Automatic sensitivity adjustment
- Compact aluminium IP67 housings
- Power, output and system status indicators
- 12-30 V dc supply voltage
- 5 wire solid state relay output
- Test inputs
- EN 12978 compliant
- TÜV approved as E-device acc. EN 12453

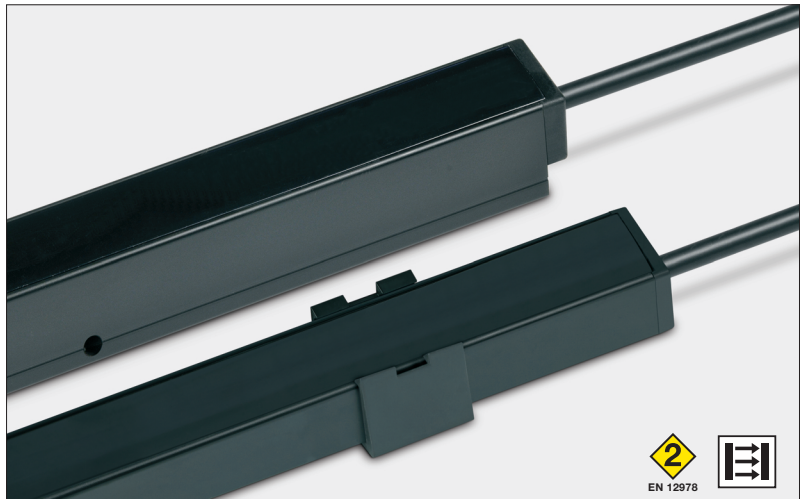

The SG 15 series is especially designed as a safety device for doors and gates. The system is approved by TÜV to be an E-device according to EN 12453, allowing it to be a stand-alone safety device on a power operated door or gate.

The SG 15 light curtain system consists of a self-contained transmitter, SGT and receiver, SGR, which are to be positioned opposite of each other. The detectors are housed in compact, but sturdy, aluminium profiles, available in two different designs.

The system is supplied with a 12-30 V dc power supply. The SGR includes a 5 wire, solid state relay output. Both the SGT and SGR include a test input which are activated simultaneously for system test purposes.

The advanced automatic signal-tracking (AST) feature ensures that no onsite set up or adjustments are required. The signal of each individual channel is adjusted automatically, which compensates for misalignment

and contamination during operation. Transmitter and receiver units are optically synchronised.

The SG 15 series features the Dynamic Sequential Blanking Function which allows the detectors to be positioned in the guide tracks of an industrial door, where the door travels directly in front of the protection area, interrupting the beams sequentially from top to bottom. The special feature ensures that the system can distinguish between the closing door and an object by ignoring the beams that are obstructed by the moving door whilst leaving the below remaining beams active to detect an object below the door edge.

Both the transmitter and receiver units are protected against reverse polarity of power supplies, control input and output signals. The output is also protected against short circuit and inductive loads.

Technical Data		SGT	SGR
Supply voltage		12-30 V dc	
Current consumption		70 mA (RMS)	30 mA
Max output load	Solid state	-	100 mA
Short circuit protected		-	Yes
Inductive load protection		-	Yes
Reverse polarity protected		Yes	
Light source		Infrared (880 nm)	-
Number of channels (diodes per detector)		16, 18, 20, 28, 30, 32, 40, 48 or 56	
Number of parallel beams		16, 18, 20, 28, 30, 32, 40, 48 or 56	
Active height		1800, 2160 or 2520 mm	
Bottom spacing to Ch 1		45 mm	
Channel spacing	C1	45 mm : all channels	
	D1	45 mm : up to 1035 mm and two top channels 180 mm : from 1035 mm to top	
	E1	45 mm : up to 315 mm and two top channels 180 mm : from 315 mm to top	
Response time		-	50 ms
Maximum sequential blanking speed		0,9 m/s	
Minimum size of detectable objects		50 mm / 200 mm	
Power on indicator		Green LED	
Output indicator		-	Yellow LED
System status indicator		Red LED	
Opening angle		-	+/- 4°
Emission angle		+/- 5°	-
Housing dimensions (w x d)	K-profile	19,5 mm x 14,8 mm	
	G-profile	19,5 mm x 21,3 mm	
Housing material	Profile	Aluminium (black anodised)	
	Lens cover	Polycarbonate	
Connection		15 m fixed cable or 5 pin, M12 plug	5 m fixed cable or 5 pin, M12 plug
Cable, PVC Ø 4,9 mm		3 x 0,20 mm <sup>2</sup>	5 x 0,20 mm <sup>2</sup>

Environmental Data		
	SGT	SGR
Light immunity @ 5° incidence	-	100 000 lux
Temperature, operation	-20 to +65 °C	
Temperature, storage	-40 to +80 °C	
Sealing class	IP 67	
Certificates		
Safety category	EN 12978:2003 EN 13849-1, Cat. 2, PL d IEC 61496-2, Type 2 ESPE	
Tested	EN 12978:2003 +A1:2009 EN ISO 13849-1:2008 EN 61508:2010 Parts 1-7 IEC 61000-6-2:2005, EN 61000-6-3:2007 +A1:2011 IEC 61326-3-1:2008	

**Available Types**

K-profile										
Transmitter	Housing Length	Active Height	Number of Channels	Channel Placement	Connection		SGT: 15 m cable / SGR: 5 m cable		0.5 m cable with 5 pin, M12 plug	
							Order Reference			
Transmitter	1948 mm	1800 mm	40	C1	-	-	SGT 15-193-040-C1-K-00-15		SGT 15-193-040-C1-K-00-0.5-J5	
			28	D1			SGT 15-193-028-D1-K-00-15		SGT 15-193-028-D1-K-00-0.5-J5	
			16	E1			SGT 15-193-016-E1-K-00-15		SGT 15-193-016-E1-K-00-0.5-J5	
	2308 mm	2160 mm	48	C1			SGT 15-229-048-C1-K-00-15		SGT 15-229-048-C1-K-00-0.5-J5	
			30	D1			SGT 15-229-030-D1-K-00-15		SGT 15-229-030-D1-K-00-0.5-J5	
			18	E1			SGT 15-229-018-E1-K-00-15		SGT 15-229-018-E1-K-00-0.5-J5	
	2668 mm	2520 mm	56	C1			SGT 15-265-056-C1-K-00-15		SGT 15-265-056-C1-K-00-0.5-J5	
			32	D1			SGT 15-265-032-D1-K-00-15		SGT 15-265-032-D1-K-00-0.5-J5	
			20	E1			SGT 15-265-020-E1-K-00-15		SGT 15-265-020-E1-K-00-0.5-J5	
Receiver	1948 mm	1800 mm	40	C1	Solid State Relay	LO (NC)	SGR 15-193-040-C1-K-09-5		SGR 15-193-040-C1-K-09-0.5-J5	
			28	D1			SGR 15-193-028-D1-K-09-5		SGR 15-193-028-D1-K-09-0.5-J5	
			16	E1			SGR 15-193-016-E1-K-09-5		SGR 15-193-016-E1-K-09-0.5-J5	
	2308 mm	2160 mm	48	C1			SGR 15-229-048-C1-K-09-5		SGR 15-229-048-C1-K-09-0.5-J5	
			30	D1			SGR 15-229-030-D1-K-09-5		SGR 15-229-030-D1-K-09-0.5-J5	
			18	E1			SGR 15-229-018-E1-K-09-5		SGR 15-229-018-E1-K-09-0.5-J5	
	2668 mm	2520 mm	56	C1			SGR 15-265-056-C1-K-09-5		SGR 15-265-056-C1-K-09-0.5-J5	
			32	D1			SGR 15-265-032-D1-K-09-5		SGR 15-265-032-D1-K-09-0.5-J5	
			20	E1			SGR 15-265-020-E1-K-09-5		SGR 15-265-020-E1-K-09-0.5-J5	

G-profile										
Transmitter	Housing Length	Active Height	Number of Channels	Channel Placement	Connection		SGT: 15 m cable / SGR: 5 m cable		0.5 m cable with 5 pin, M12 plug	
							Order Reference			
Transmitter	1948 mm	1800 mm	40	C1	-	-	SGT 15-193-040-C1-G-00-15		SGT 15-193-040-C1-G-00-0.5-J5	
			28	D1			SGT 15-193-028-D1-G-00-15		SGT 15-193-028-D1-G-00-0.5-J5	
			16	E1			SGT 15-193-016-E1-G-00-15		SGT 15-193-016-E1-G-00-0.5-J5	
	2308 mm	2160 mm	48	C1			SGT 15-229-048-C1-G-00-15		SGT 15-229-048-C1-G-00-0.5-J5	
			30	D1			SGT 15-229-030-D1-G-00-15		SGT 15-229-030-D1-G-00-0.5-J5	
			18	E1			SGT 15-229-018-E1-G-00-15		SGT 15-229-018-E1-G-00-0.5-J5	
	2668 mm	2520 mm	56	C1			SGT 15-265-056-C1-G-00-15		SGT 15-265-056-C1-G-00-0.5-J5	
			32	D1			SGT 15-265-032-D1-G-00-15		SGT 15-265-032-D1-G-00-0.5-J5	
			20	E1			SGT 15-265-020-E1-G-00-15		SGT 15-265-020-E1-G-00-0.5-J5	

Receiver	1948 mm	1800 mm	40	C1	Solid State Relay	LO (NC)	SGR 15-193-040-C1-G-09-5		SGR 15-193-040-C1-G-09-0.5-J5	
			28	D1			SGR 15-193-028-D1-G-09-5		SGR 15-193-028-D1-G-09-0.5-J5	
			16	E1			SGR 15-193-016-E1-G-09-5		SGR 15-193-016-E1-G-09-0.5-J5	
	2308 mm	2160 mm	48	C1			SGR 15-229-048-C1-G-09-5		SGR 15-229-048-C1-G-09-0.5-J5	
			30	D1			SGR 15-229-030-D1-G-09-5		SGR 15-229-030-D1-G-09-0.5-J5	
			18	E1			SGR 15-229-018-E1-G-09-5		SGR 15-229-018-E1-G-09-0.5-J5	
	2668 mm	2520 mm	56	C1			SGR 15-265-056-C1-G-09-5		SGR 15-265-056-C1-G-09-0.5-J5	
			32	D1			SGR 15-265-032-D1-G-09-5		SGR 15-265-032-D1-G-09-0.5-J5	
			20	E1			SGR 15-265-020-E1-G-09-5		SGR 15-265-020-E1-G-09-0.5-J5	

Note: 1. Different test input configurations are available upon request.  
 2. The SG 15 series is available with OSE, 900 Hz 5 V square signal output upon request.

**Connections**

	Cable	M12 Plug / Cable
Supply +	Brown	Pin 1 / Brown
Supply -	Blue	Pin 3 / Blue
SGT test input	Black	Pin 4 / Black
SGR test input	White	Pin 2 / White
SGR output	Black	Pin 4 / Black
SGR output	Black	Pin 5 / Grey

**5 pin, M12**

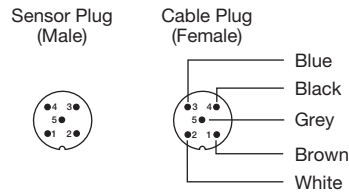

**Wiring Diagrams**

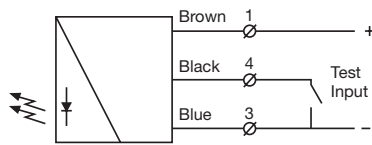

**SGT 15**  
Connect black wire to '-'  
to activate test input

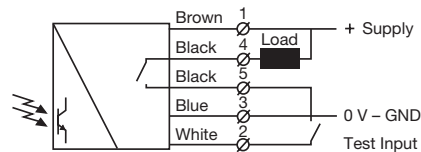

**SGR 15**  
Load as NPN output

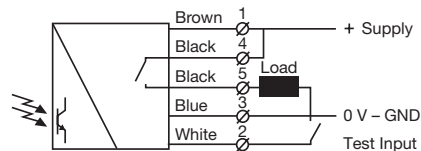

**SGR 15**  
Load as PNP output

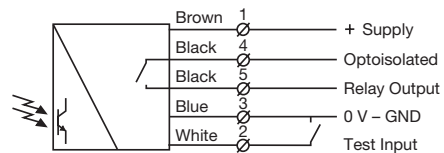

**SGR 15**  
Solid state relay output

Dimensions and Descriptions

K-profile

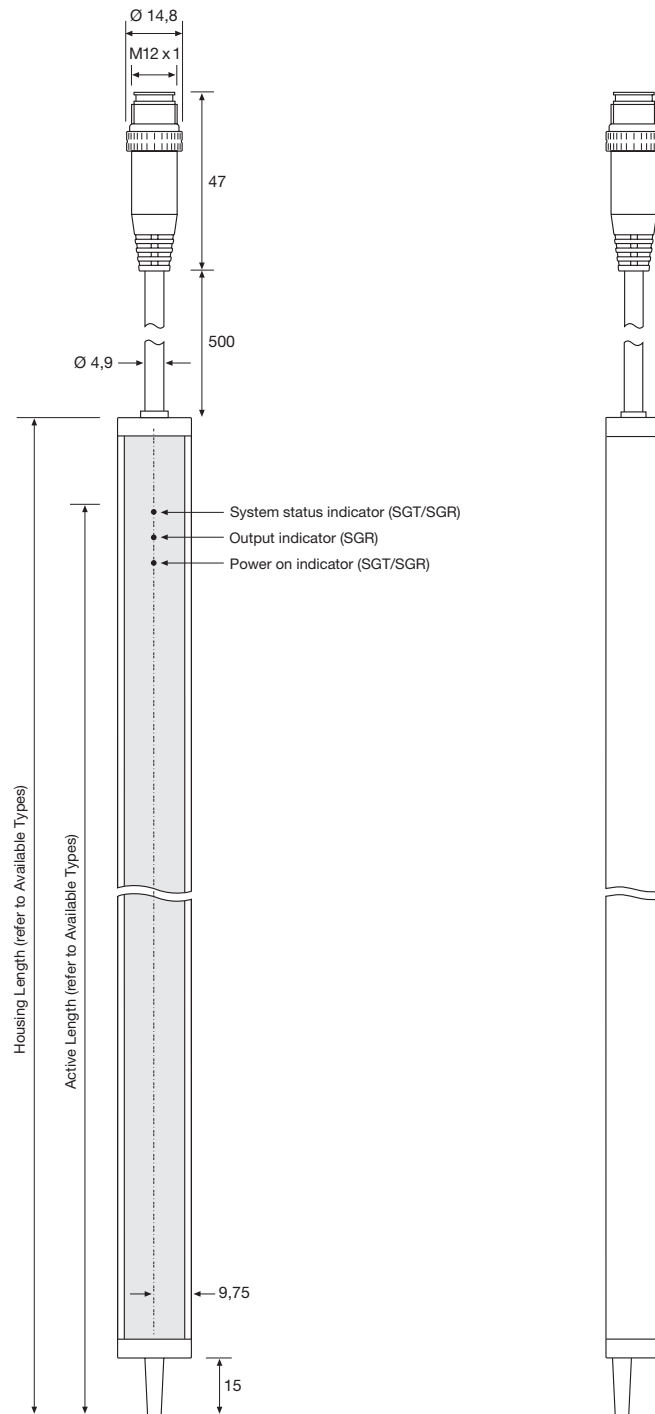

Housing Length (refer to Available Types)

Active Length (refer to Available Types)

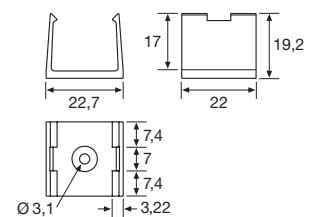
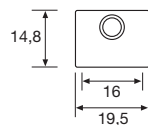

**TR PSC23 K**  
(6 pcs included with each set)

Note: Drawing shows model with M12 plug.

(Units in mm)

Dimensions and Descriptions

G-profile

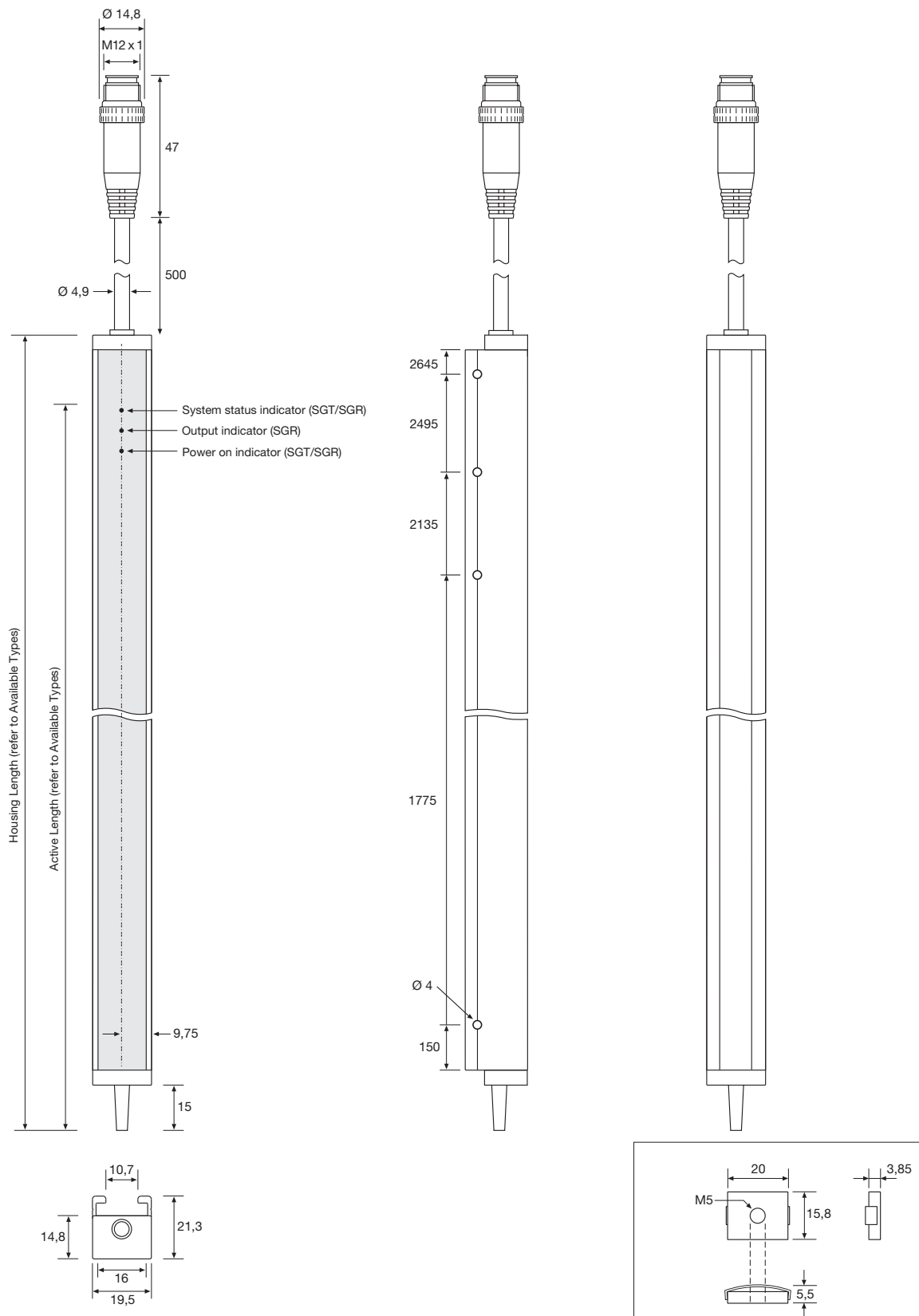

Note: Drawing shows model with M12 plug.

(Units in mm)

Beam Patterns

1948 mm housing length

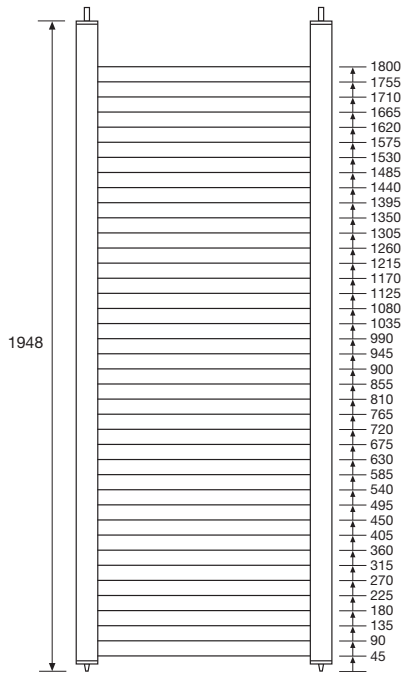

C1

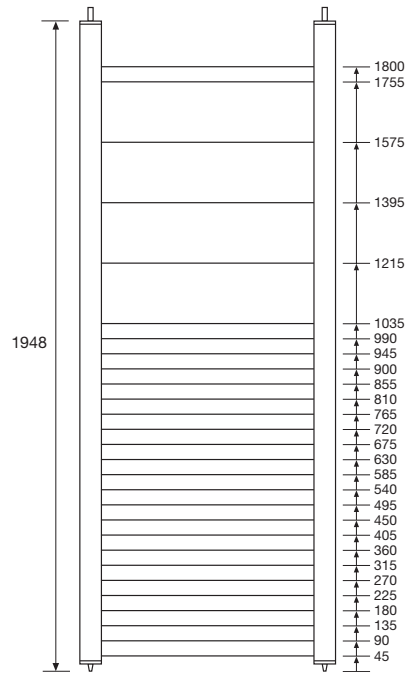

D1

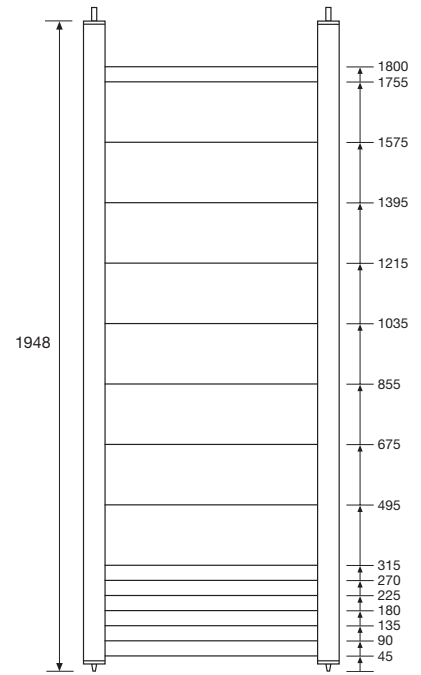

E1

2308 mm housing length

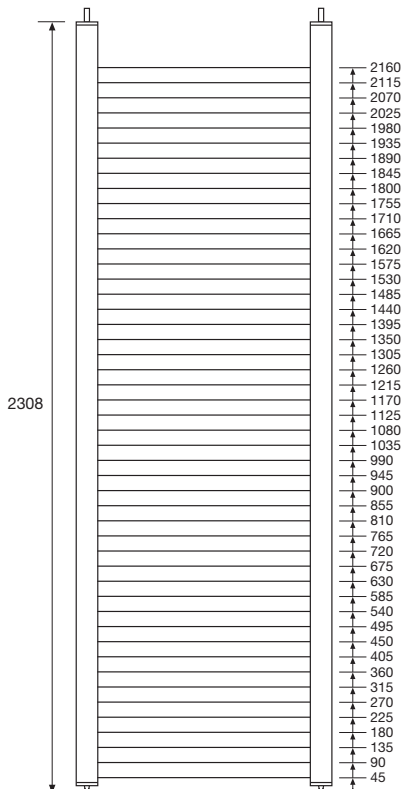

C1

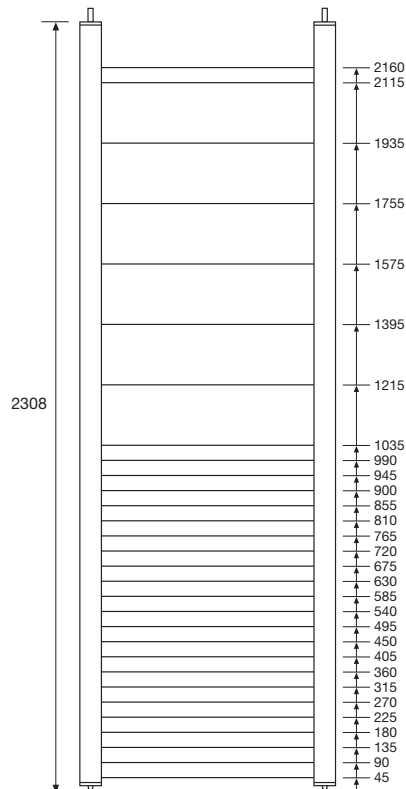

D1

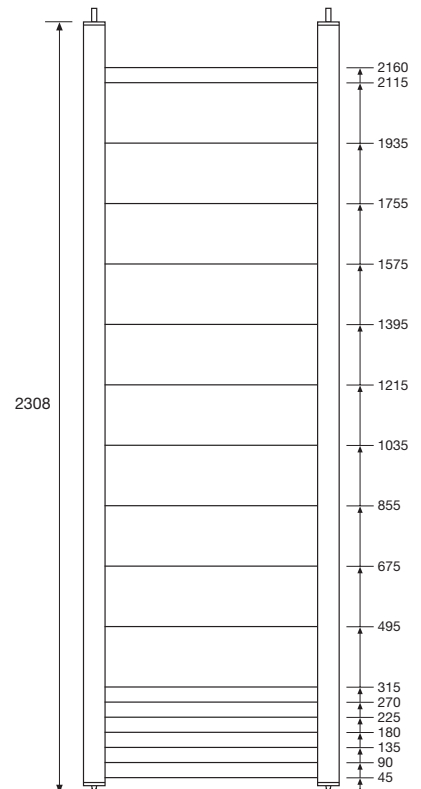

E1

(Units in mm)

Beam Patterns

2668 mm housing length

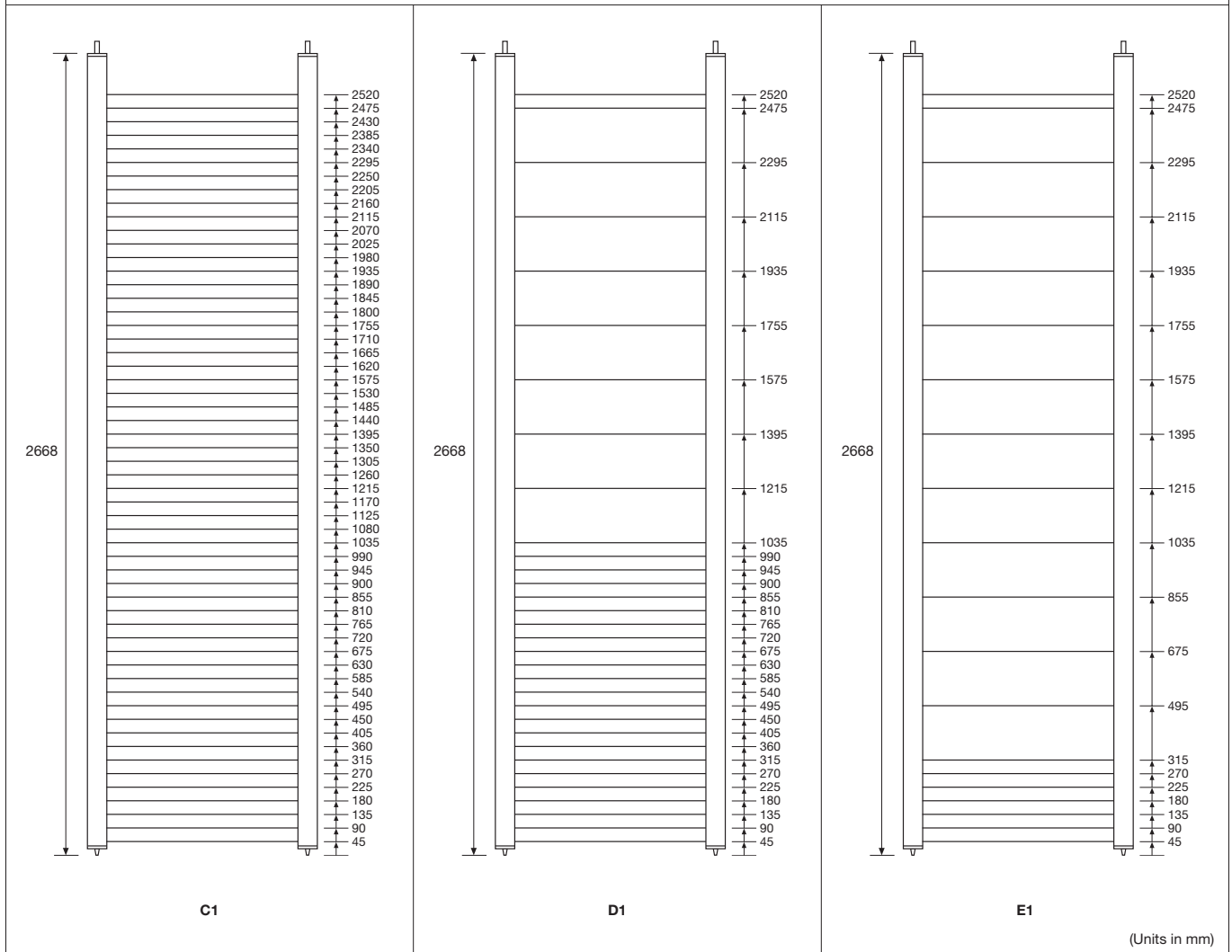

Timing Diagram

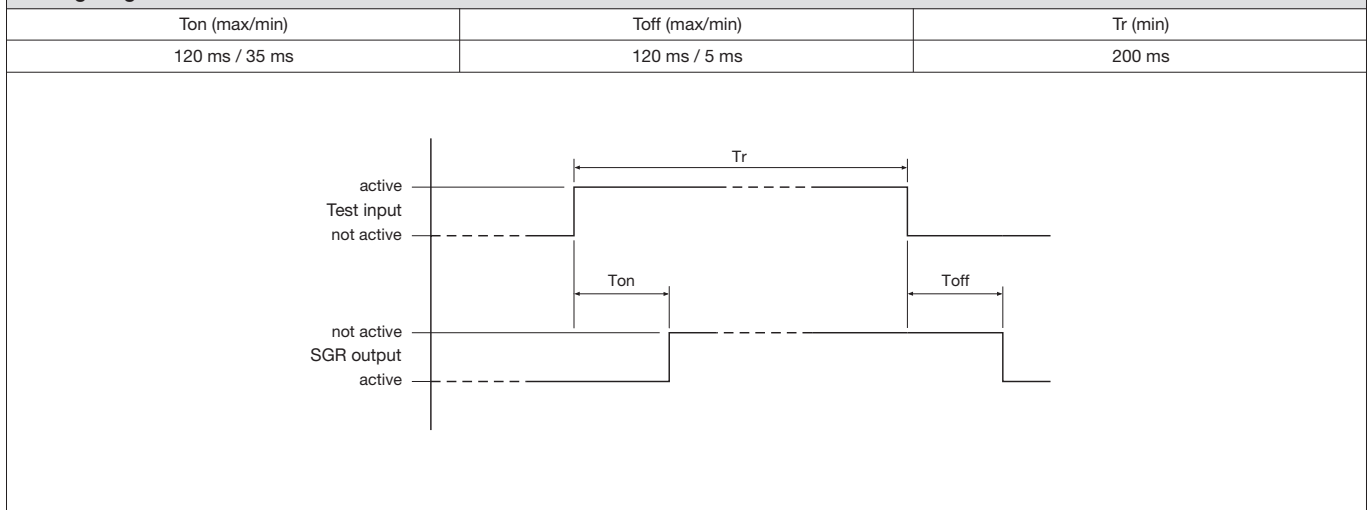

Sensing Characteristics

Parallel Displacement

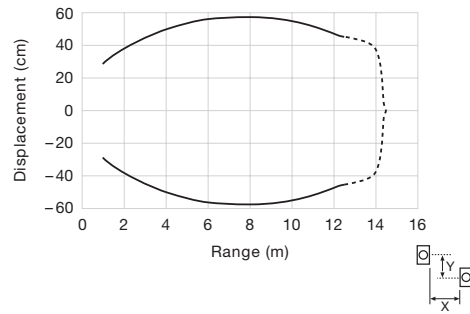

Applications

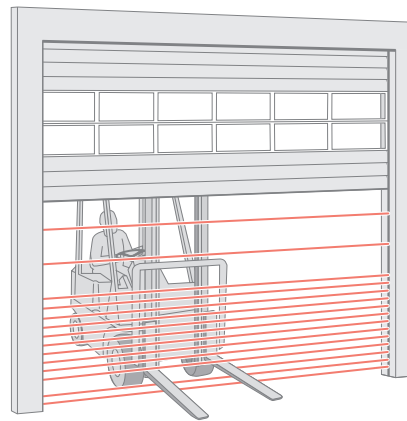

OVERHEAD DOOR

Telco reserves the right to change specifications without notice.